

ASSEMBLY INSTRUCTION

H10081 TABLE LAMP

No special tools are needed to install this table lamp. Be sure to follow the steps in assembly instruction given. If you are unclear for how to proceed, consult a qualified electrician.

IMPORTANT SAFETY INSTRUCTION :

- To prevent shock, only plug in unit after completed assembly.
- Do not exceed the maximum wattage rating as suggested.
- Before switch on the lamp, please follow the instruction step by step.
- Do not recommend to keep on the light exceed 12 hours.
- Replace the bulb when the glass tube and base is completely cold.
- This product is intended for indoor use only and should be positioned in a dry location and away from sunlight.
- Please keep away from children and pets to prevent breakage from fall or tip over.

Note : this table lamp has a polarized plug(one blade is wider than the other). As a safety feature, this plug will fit in a polarized outlet only in one way. If the plug does not fit fully in the outlet, reverse the plug. If it still does not fit, contact a qualified electrician. Never use with an extension cord unless plug can be fully inserted. Do not modify or change from the original lamp polarized plug to fit to different outlet.

Step 1: Take out the table lamp and parts from the package slowly. Place the table lamp on smooth and stable table/desk top.

Step 2: Release the bolts and remove the glass. (Figure 1)

Step 3: Align and insert the glass tube then put the sleeve in the base. (Figure 2)

Step 4: Mount the glass and let the sticker side facing outward. Align the harp to the harp holder, hold and press it into the holder.(Figure 3)

Step 5: Day light: Do not exceed maximum 100 watt or 23 watt for energy saving UL listed bulbs.

Only replace LED bulbs with proper wattage as assigned from the bulb packing.

Step 6: Night light: Do not exceed maximum 25 watt UL listed bulbs, It is not compatible to replace with LED bulbs.





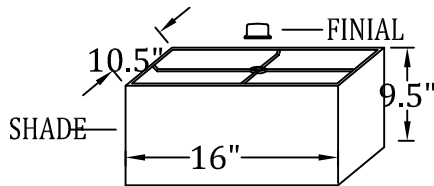
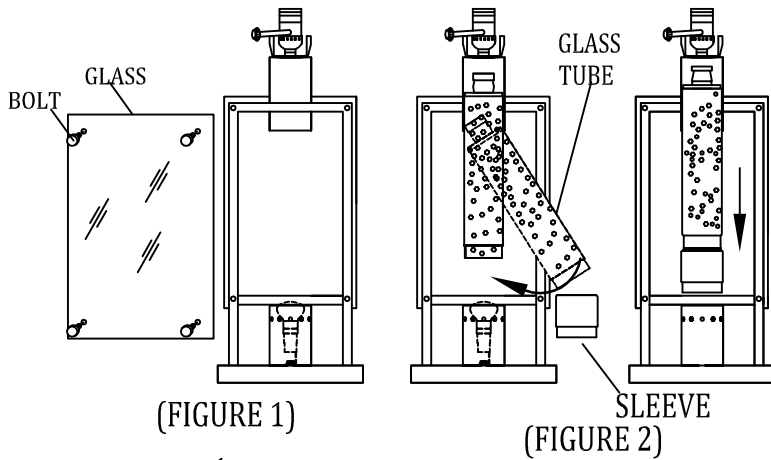

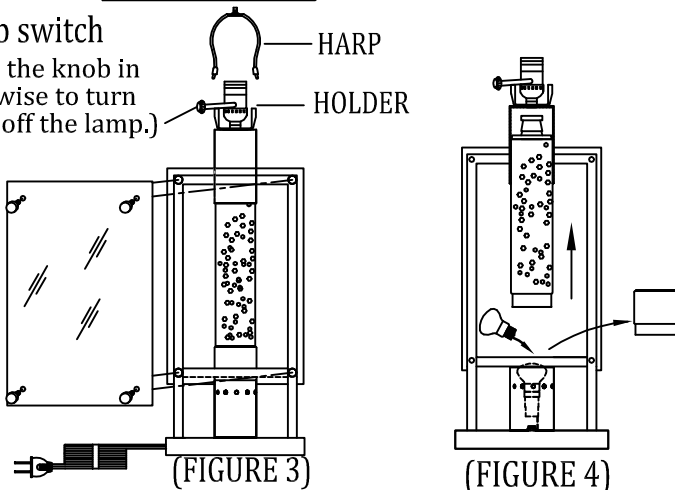

Step 7: Remove the plastic dust cover from the shade. Place the shade onto the top of the harp, tighten with finial to fix and secure the shade in position.

Step 8: Insert the polarized plug to the proper outlet. Switch to turn on or off the lamp.



Knob switch
(Turn the knob in clockwise to turn on or off the lamp.)



PARTS LIST			
NO.	DRAWING	QTY	DESCRIPTION
1		1	BASE
2		1	SLEEVE
3		1	GLASS TUBE
4		3	BULB (TYPE R, E17)
5		1	GLASS
6		4	BOLT
7		1	SHADE
8		1	FINIAL
9		1	HARP

How to replace the light bulb :

1. Release the bolts and remove the glass (Figure 1).
2. Lift the glass tube and remove the sleeve ,replace the bulb(Figure 4).
3. Put the sleeve back(Figure 2).
4. Mount the glass and let the sticker side facing outward.

Care Instruction

To clean the lamp, wipe with a soft cloth. Do not use abrasive materials such as chemical pad, paper or cleaner.