



ASSEMBLY INSTRUCTION

9539DGY/BGE-5A (1/2) OVERSIZED CHAISE LOUNGE ARM WITH USB PORT
 9539DGY/BEG-5B (2/2) OVERSIZED CHAISE LOUNGE BASE WITH PILLOWS



Thank you for being our valued customer. Be sure to check all packing materials carefully for small parts which have come loose inside the carton during shipment. Identify and count all items and compare them with the parts list below.

CAUTION: Read the Instructions carefully before assembly.



1. We recommend that you should assemble this product with the assistance of another person; this will make assembly easier, and will help to eliminate damage the product or injury to persons during assembly.
2. When you want to reposition the product, please always "LIFT & MOVE".

NOTE: Do not use power tools for assembly. Power tools increase the risk of over tightening which leads to splitting or cracking the wood.

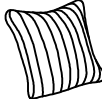
PART LIST (packed in 9539 DGY/BEG-56)

NO.	PART NAME	DESCRIPTION	Q'TY (PC)
①	SEAT BASE		1
②	BACK REST		1
③	SMALL PILLOW (420x420mm)		2
④	BIG PILLOW (520x520mm)		3

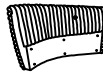
PART LIST (packed in 9539 DGY/BEG-55)





NO.	PART NAME	DESCRIPTION	Q'TY (PC)
⑤	RSF ARM W/USB		1
⑥	LSF ARM W/USB		1
⑦	ADAPTOR PLUG W/WIRE		2



ASSEMBLY INSTRUCTION

9539DGY/BGE-5A (1/2) OVERSIZED CHAISE LOUNGE ARM WITH USB PORT
9539DGY/BEG-5B (2/2) OVERSIZED CHAISE LOUNGE BASE WITH PILLOWS

HARDWARE LIST (packed in 9539 DGY/BEG-5A)

NO.	PART NAME	DESCRIPTION	Q'TY (PC)
(A)	THERED BOLT 5/16"90mm		17
(B)	HEX NUT		17
(C)	FLAT WASHER 5/16" x 25mm"		17
(D)	WRENCH		1

STEP 1: The **PILLOW (3)**, **(4)** and **BACKREST (2)** are stored at the bottom of **SEAT BASE (1)**, open the zipper to take it out for assembly.

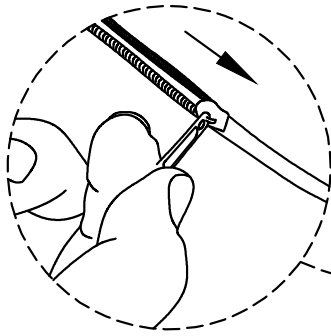

OPENING THE ZIPPER
HERE FOR ASSEMBLY.

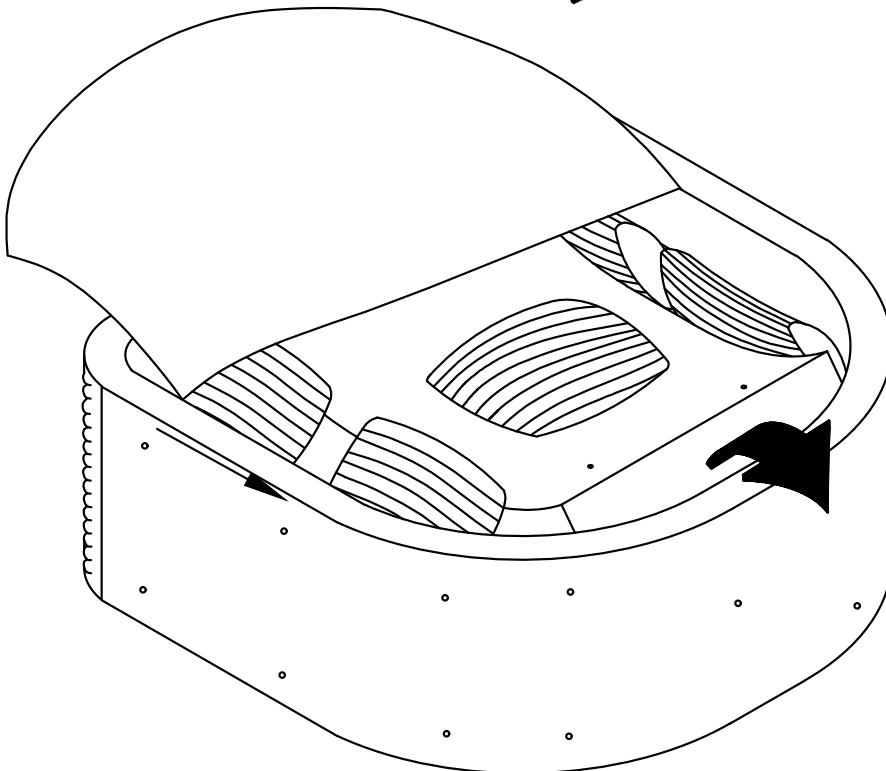
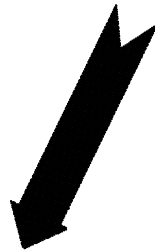
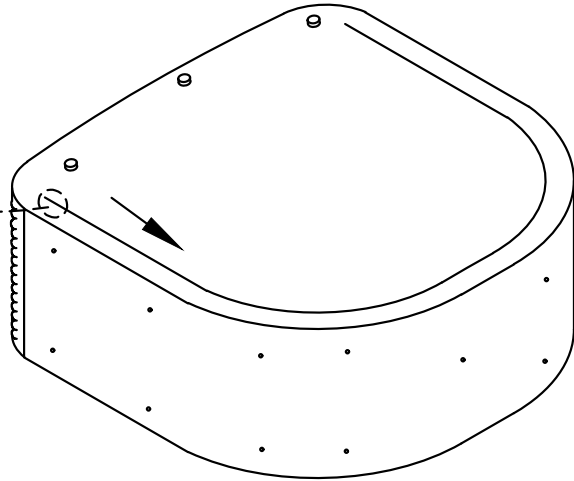

STEP 2

TIPS: To get easy for assembly, consumer can assemble and tight four bolts of two side to the seat base in advance, then just tighten for the middle bolts later.

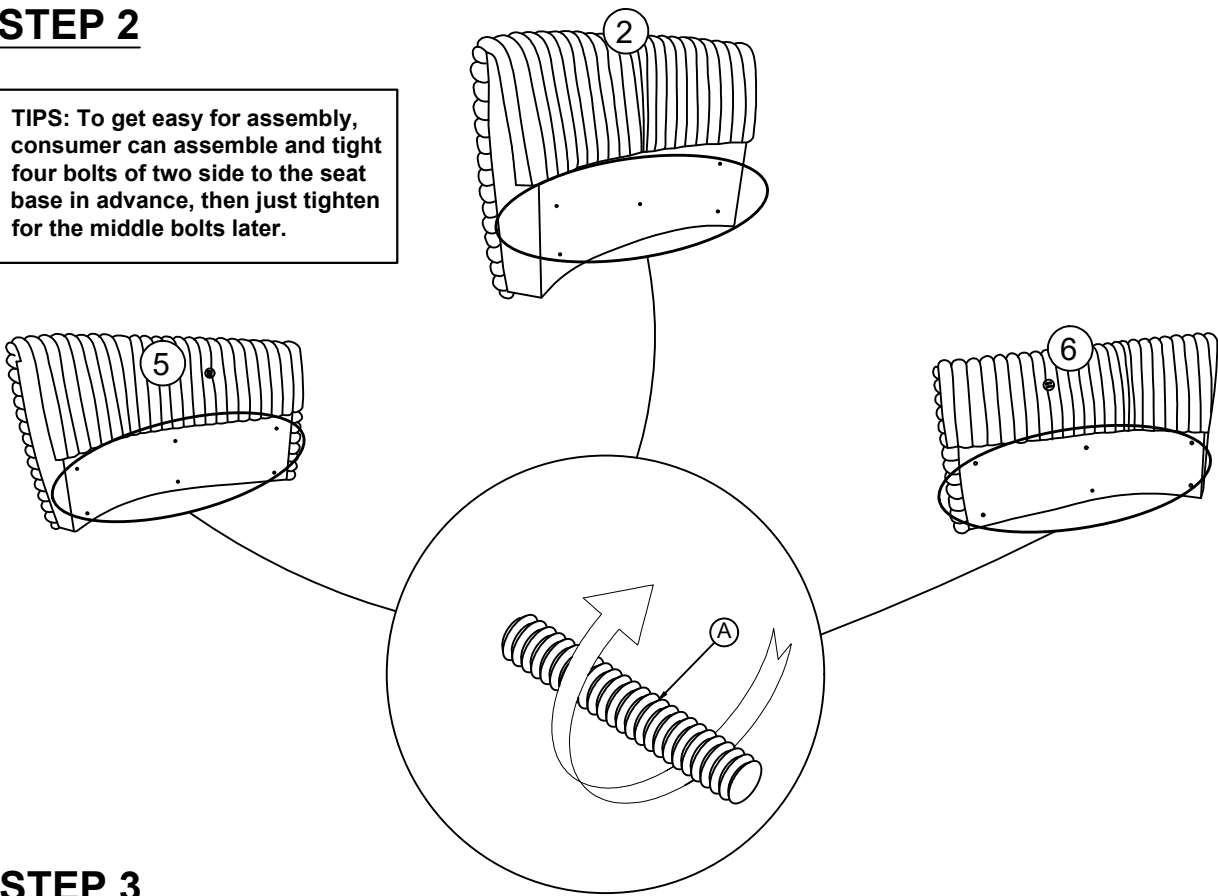

STEP 3

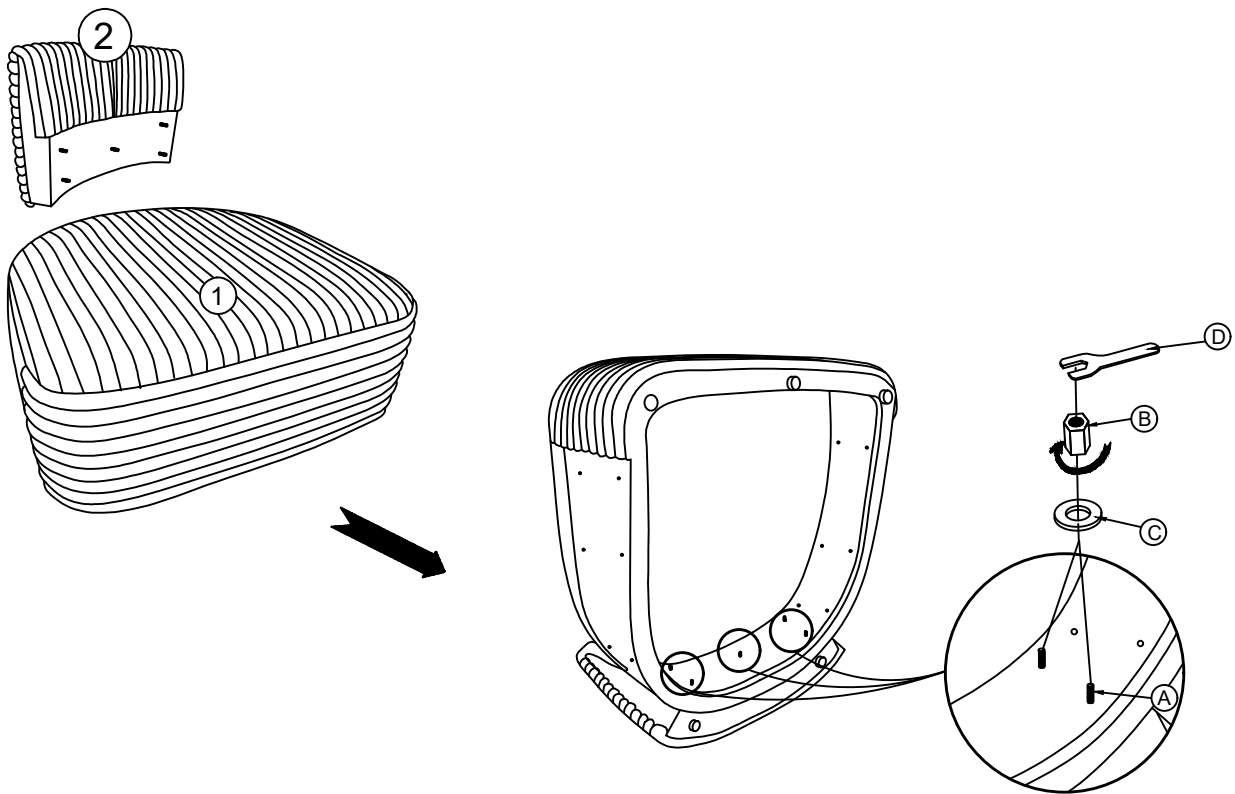

STEP 4

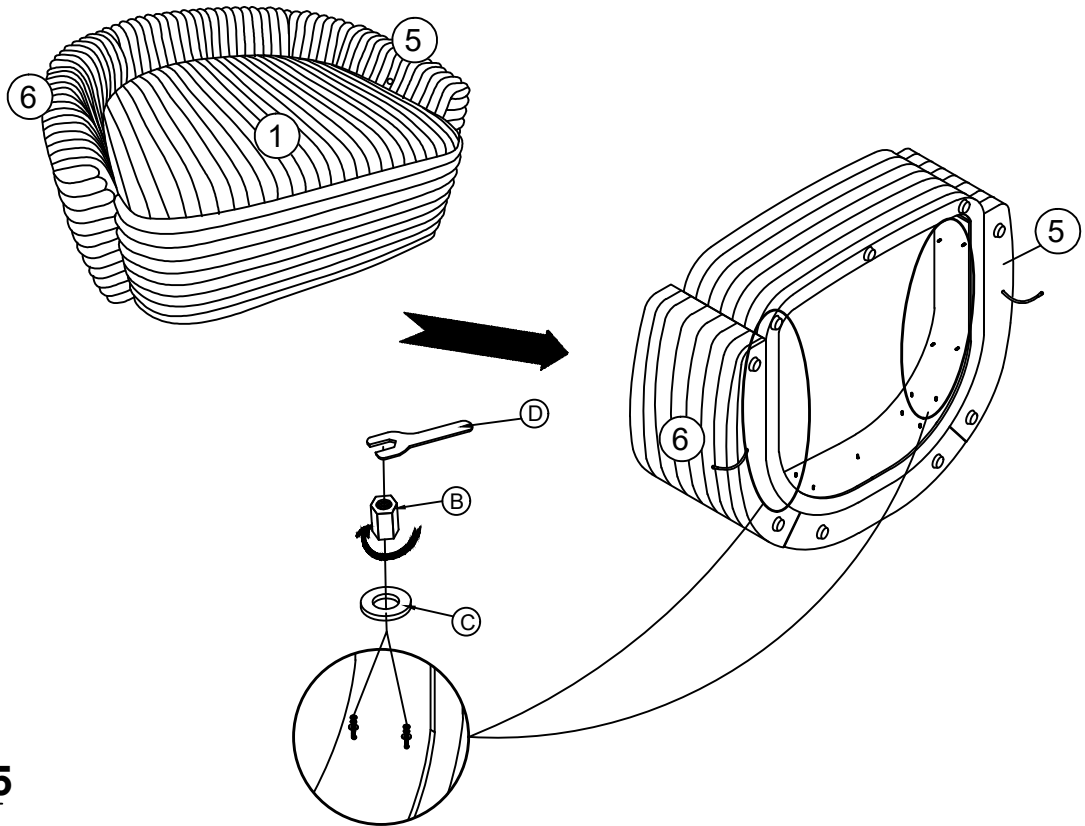

STEP 5

Connect wire with adapter plug

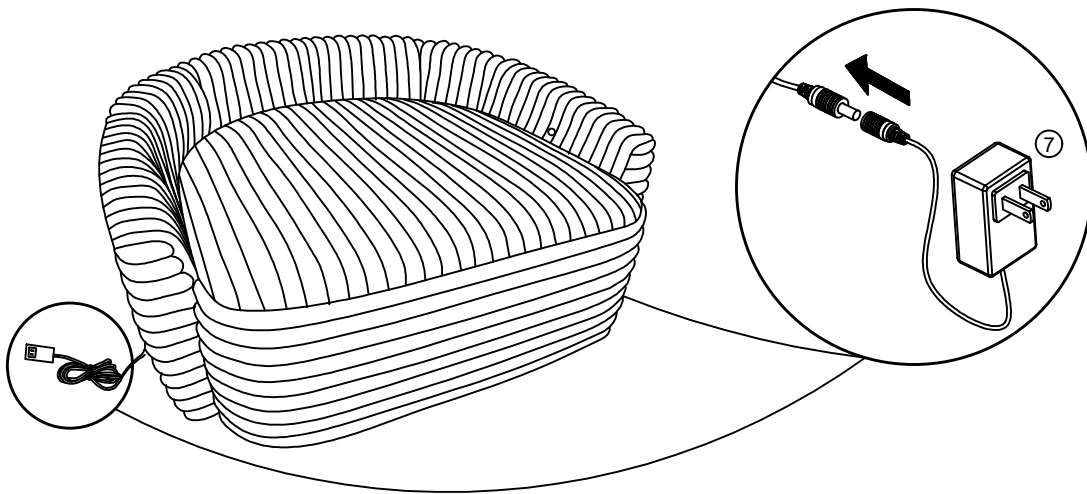

STEP 6

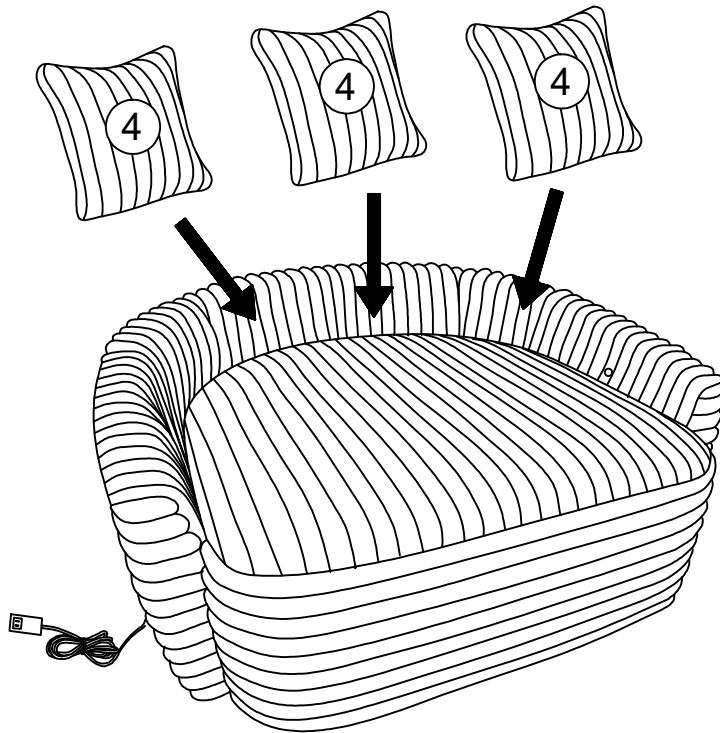

STEP 7



Completed

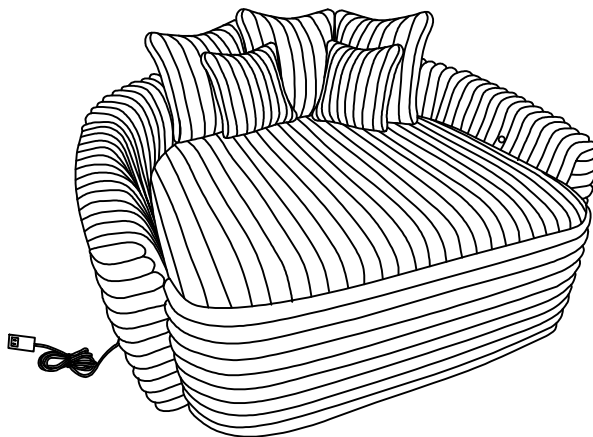

Connect power

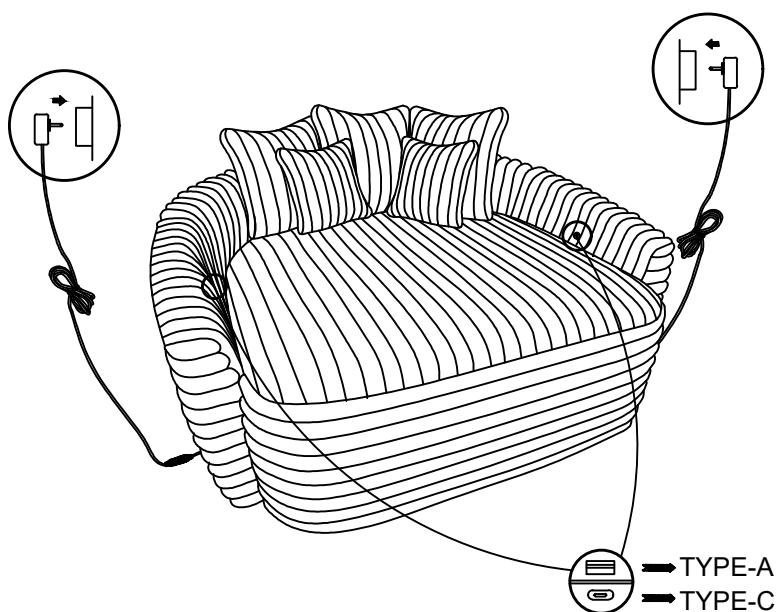

CARE INSTRUCTION FOR FABRIC FURNITURE:

In order to maintain the original appearance of your polyester furniture, please follow below simple care procedure:

- Avoid exposing furniture directly to sunlight or heating and air conditioning outlets. Exposure to sunlight or heating and air conditioning outlets will fade/damage polyester.
- Wipe gently with a damp soft cloth to remove dust, dirt and any grime build up.
- Hardware may loosen over time. Periodically check to make sure all connections are tight. Re-tighten if necessary