



ASSEMBLY INSTRUCTION

LEFT SIDE RECLINING LOVE SEAT WITH CENTER CONSOLE

ITEM NO: 9510-2LCN

NOTE: Do not use power tools for assembly. Power tools increase the risk of over tightening which lead to splitting or cracking the wood.

COMPONENT LIST

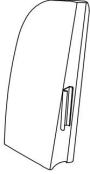
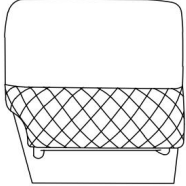
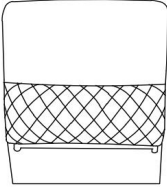
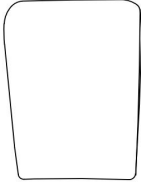
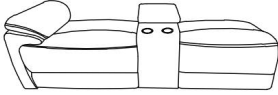
NO.	DRAWING	QTY	DESCRIPTION
A		1	LSF EAR
B		1	LSF BACK REST
C		1	RSF BACK REST
D		1	CONSOLE BACK REST
E		1	SEAT

Please follow the drawings below to assemble the item.

Step 1. Console back rest is stored in plastic bag at the bottom of the console. Please take out for assembly.

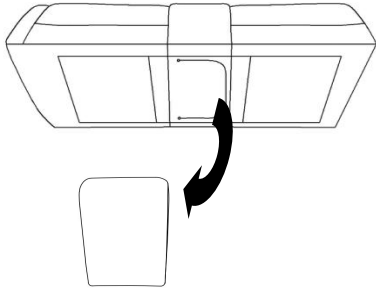

Step 2. Align the female brackets at the back rest onto the male brackets at the seat, insert and push to the end, make sure the brackets are secured in position.

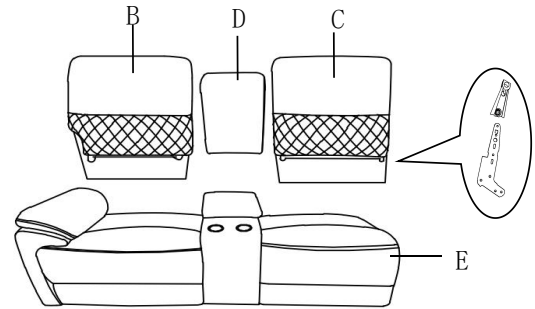

Step 3. Insert the LSF ear to the back rest and make sure it is secured in position.

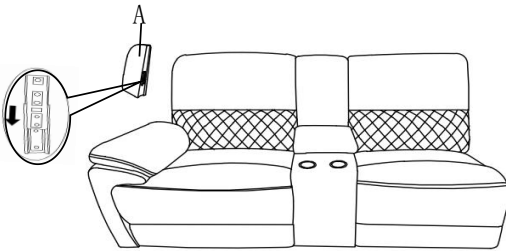

Step 4. Completed

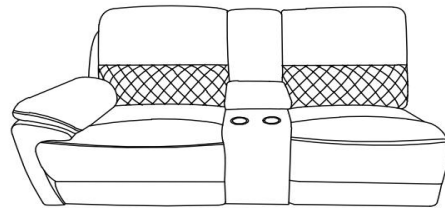

Step 5.

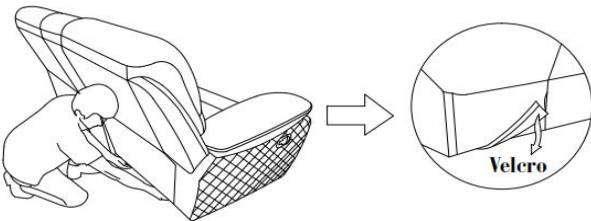

Step 6. Pull handle to recline chair

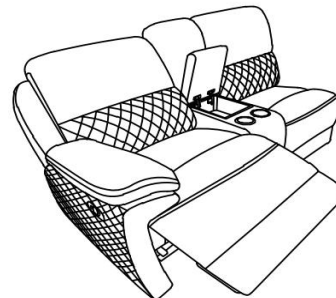

CARE INSTRUCTION FOR FABRIC:

In order to maintain the original appearance of your fabric furniture, please follow below simple care procedure :

- Avoid exposing furniture directly to sunlight or heating and air conditioning outlets. Exposure to sunlight or heating and air conditioning outlets will fade/damage fabric.
- Wipe gently with a damp soft cloth to remove dust, dirt and any grime build up.

PLEASE KEEP ASSEMBLY INSTRUCTION FOR FUTURE REFERENCE



ASSEMBLY INSTRUCTION

CORNER SEAT

ITEM NO: 9510-CR

NOTE: Do not use power tools for assembly. Power tools increase the risk of over tightening which lead to splitting or cracking the wood.

COMPONENT LIST

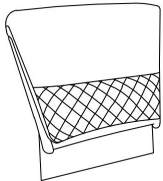
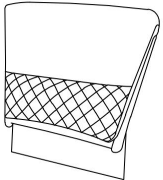
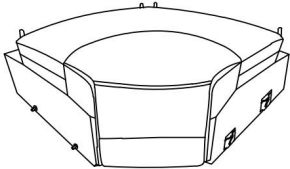
NO.	DRAWING	QTY	DESCRIPTION
A	 A line drawing of a rectangular backrest with a diamond-patterned mesh on the lower half and a solid top section.	1	LSF BACK REST
B	 A line drawing of a rectangular backrest, similar to A but with a different mesh pattern on the lower half.	1	RSF BACK REST
C	 A line drawing of a square corner seat with a curved front edge and a central opening.	1	SEAT

Please follow the drawings below to assemble the item.

Step 1. Align the female brackets at the back rest onto the male brackets at the seat, insert and push to the end, make sure the brackets are secured in position.

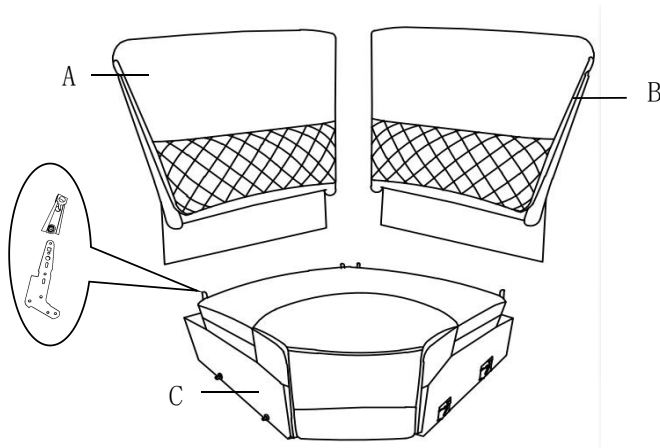

Step2. Completed

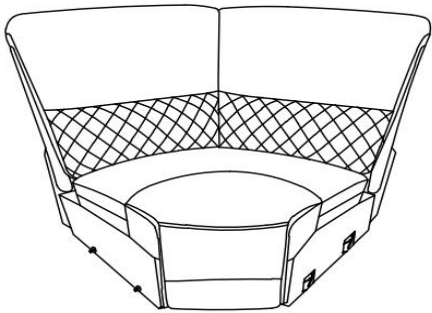

Step3.

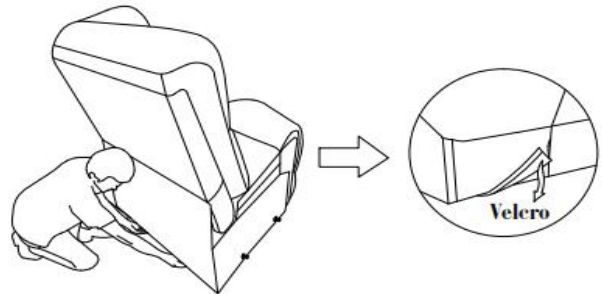

CARE INSTRUCTION FOR FABRIC:

In order to maintain the original appearance of your fabric furniture, please follow below simple care procedure :

- **Avoid exposing furniture directly to sunlight or heating and air conditioning outlets. Exposure to sunlight or heating and air conditioning outlets will fade/damage fabric.**
- **Wipe gently with a damp soft cloth to remove dust, dirt and any grime build up.**

PLEASE KEEP ASSEMBLY INSTRUCTION FOR FUTURE REFERENCE





ASSEMBLY INSTRUCTION

RIGHT SIDE RECLINING LOVE SEAT

ITEM NO: 9510-2R

NOTE: Do not use power tools for assembly. Power tools increase the risk of over tightening which lead to splitting or cracking the wood.

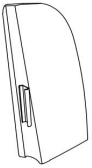
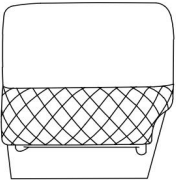
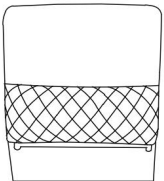
COMPONENT LIST

NO.	DRAWING	QTY	DESCRIPTION
A		1	RSF EAR
B		1	RSF BACK REST
C		1	LSF BACK REST
D		1	SEAT

Please follow the drawings below to assemble the item.

Step 1. Align the female brackets at the back rest onto the male brackets at the seat, insert and push to the end, make sure the brackets are secured in position.

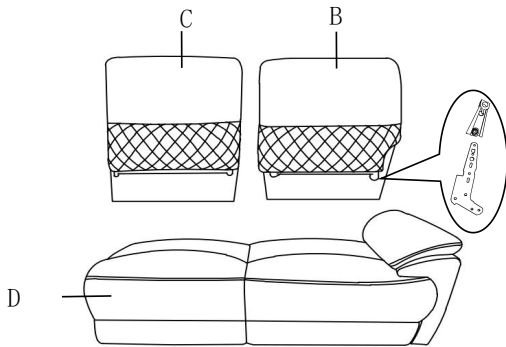

Step 2. Insert the RSF ear to the back rest and make sure it is secured in position.

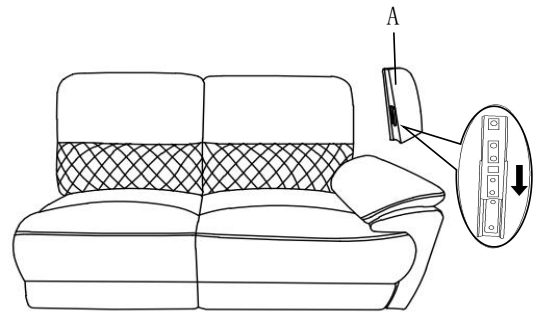

Step 3. Completed

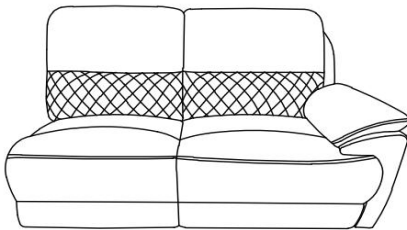

Step 4. Pull open handle to use reclining function

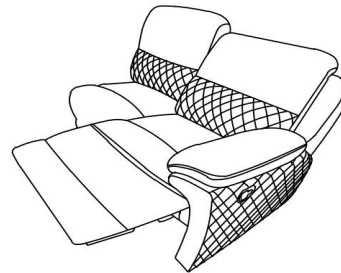

Step 5.

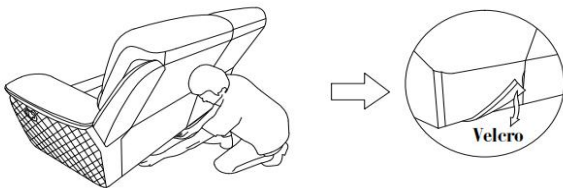

Step 6. Combine -2LCN/CR/2R to a whole set group

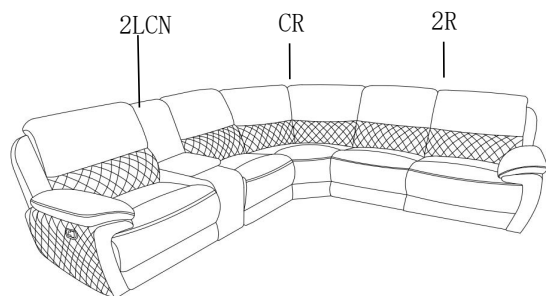

CARE INSTRUCTION FOR FABRIC:

In order to maintain the original appearance of your fabric furniture, please follow below simple care procedure :

- **Avoid exposing furniture directly to sunlight or heating and air conditioning outlets. Exposure to sunlight or heating and air conditioning outlets will fade/damage fabric.**
- **Wipe gently with a damp soft cloth to remove dust, dirt and any grime build up.**

PLEASE KEEP ASSEMBLY INSTRUCTION FOR FUTURE REFERENCE