



Assembly Instruction

ITEM NO.: 9390DG-LC





(2/2) Left Side Chaise with
Storage ottoman

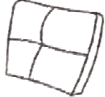
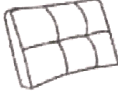

Legs and hardware are stored in the chaise storage,
please take out for assembly.

Note: Do not use power tools for assembly. Power tools increase the risk of over tightening which lead to splitting or cracking the wood.

Component list

No	Drawing	Qty	Description
A		1	SEAT
B		2	BACK CUSHION B
C		1	BACK CUSHION C
D		4	WOODEN LEG 1.96"
E		1	SUPPORT LEG 1.96"
F		1	WRENCH M6
G		8	SCREW M8" & WASHER M8"

Step #1

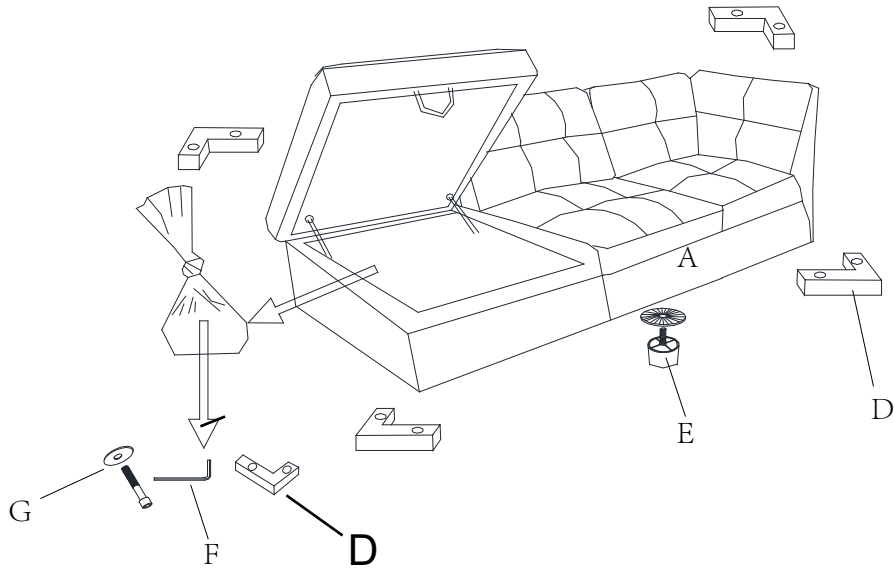

Step #2

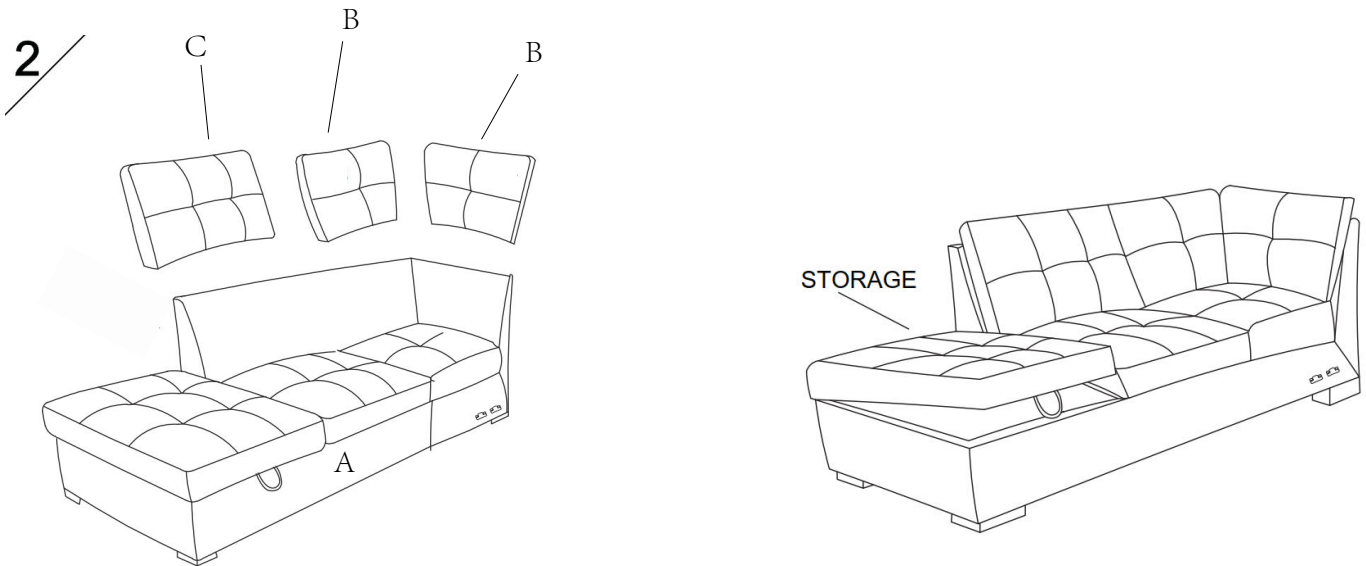

Step #3

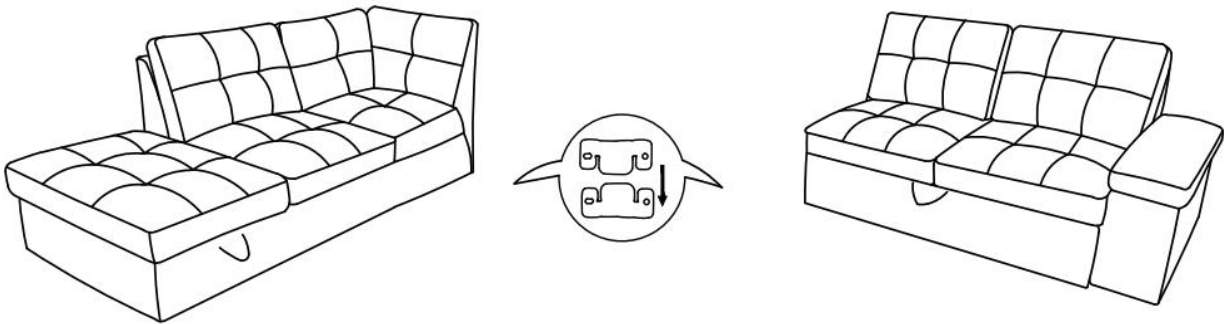

Step #4

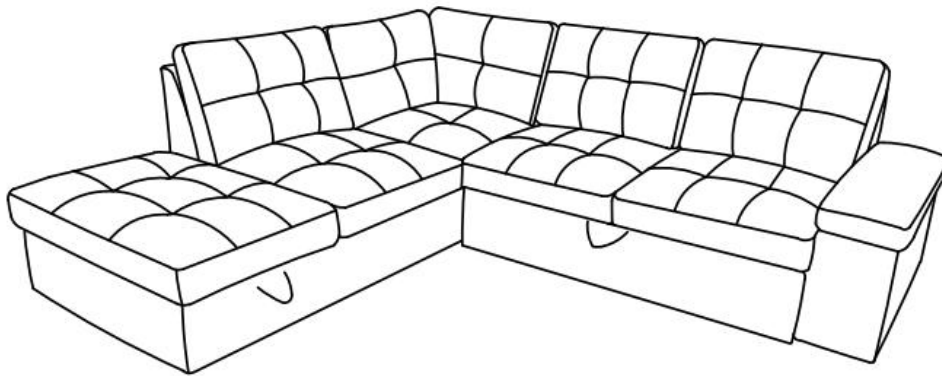

Care Instruction for Polyester Furniture

In order to maintain the original appearance of your Polyester Furniture please follow below simple care procedures:

- Avoid exposing furniture directly to sunlight or heating and air conditioning outlets. Sunlight and or exposure to heating and air conditioning outlets will fade/damage Polyester
- Vacuum or wipe with a soft cloth to remove dust.



For items use on wooden floor, hard surfaces or carpets, it is recommended to Install protective pads under all legs and supports to avoid/prevent from damages/scratches and discoloration.