

## Assembly Instruction





ITEM NO.:9329 CH-3  
SOFA

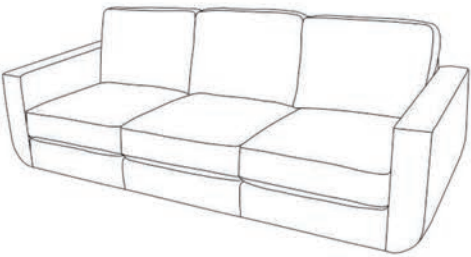
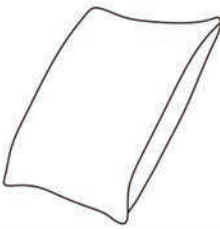

Legs & hardware are stored at the bottom of **Seat**, please take out the legs and hardware for assembly.

**Note:** Do not use power tools for assembly. Power tools increase the risk of over tightening which lead to splitting or cracking the wood.

### Component list

No	Drawing	Qty	Description
A		1	SEAT
B		2	PILLOW
C		4	WOODEN LEG
D		1	PLASTIC LEG
E		5	FLAT WASHER Φ=1.77"

Step #1

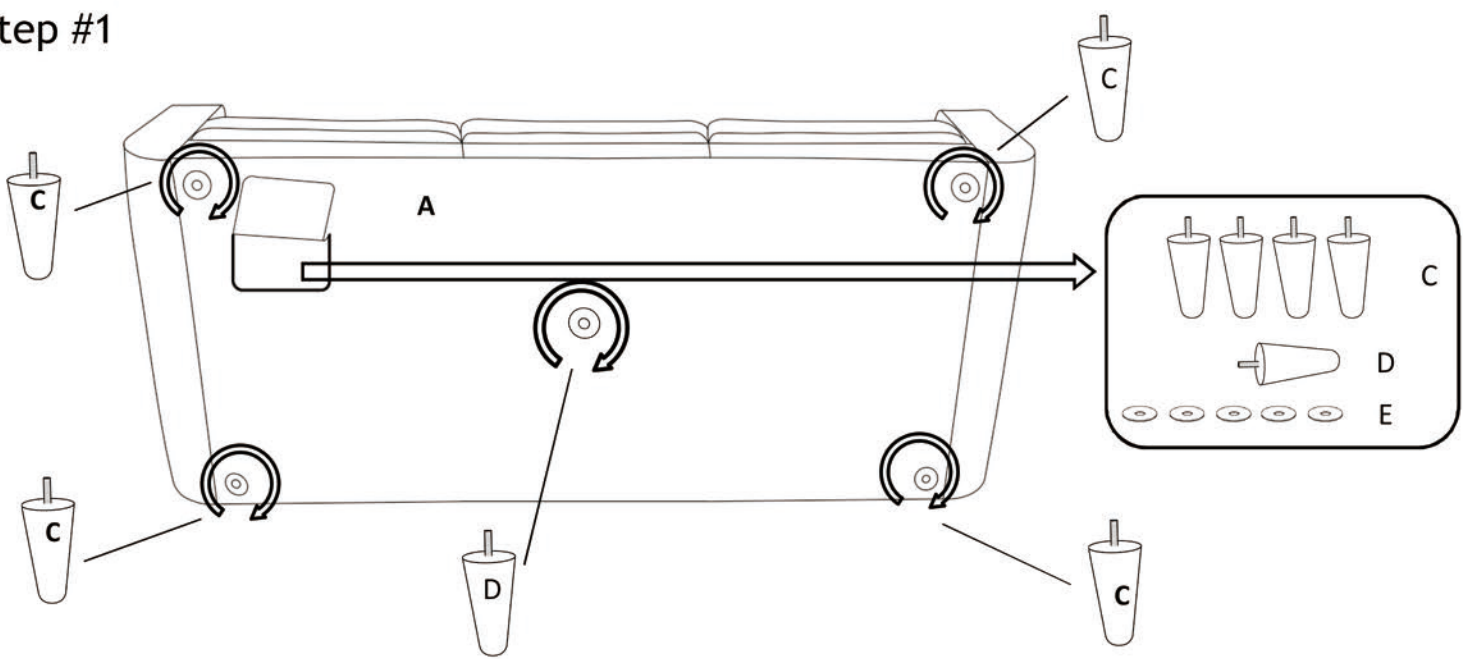

Step #2

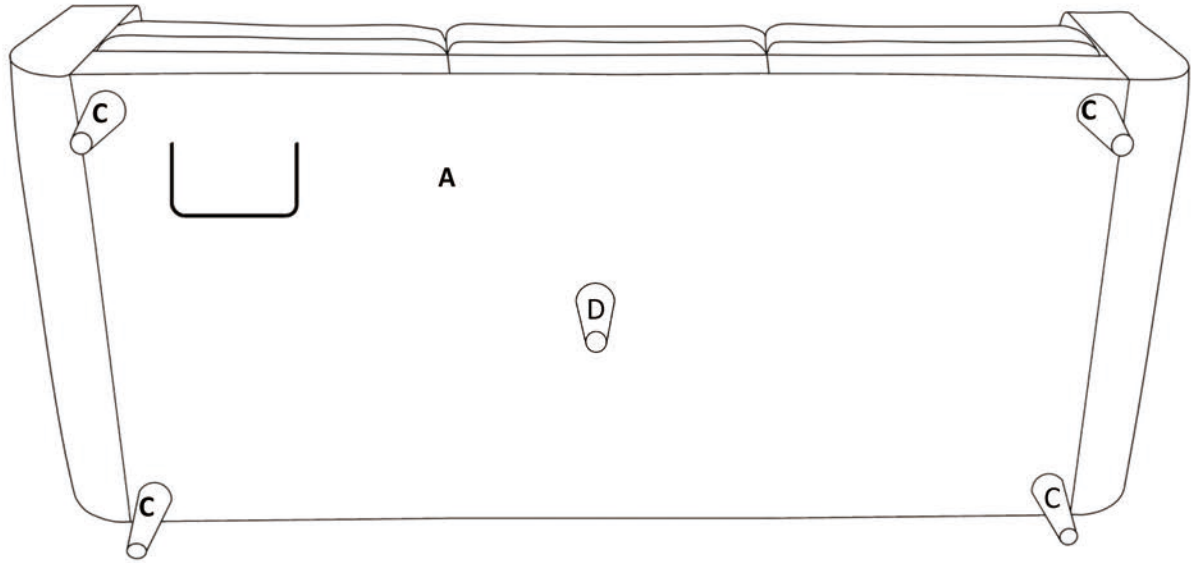

Step #3

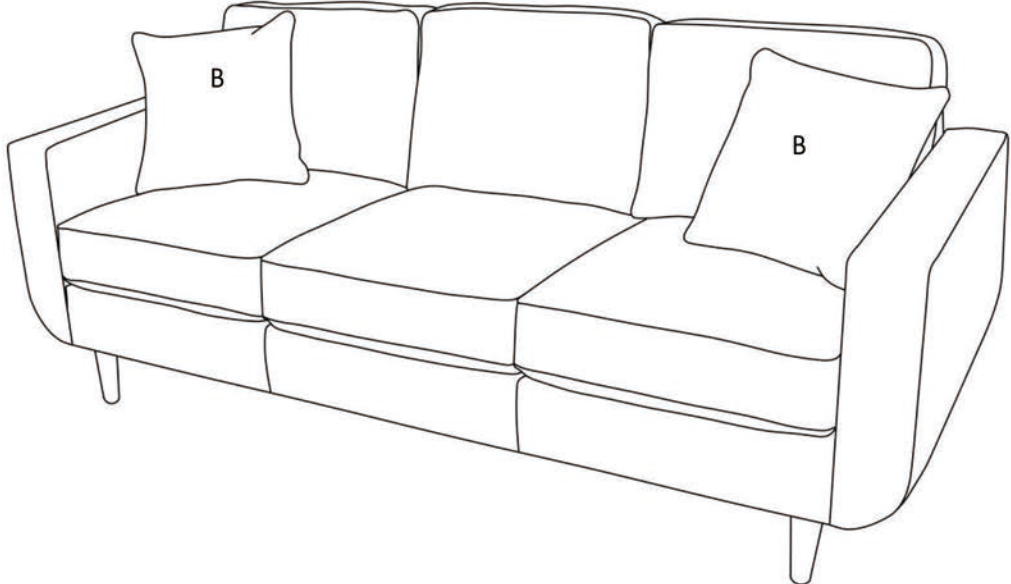

## Care Instruction for Velvet Furniture:

In order to maintain the original appearance of your Velvet Furniture, please follow below simple care procedures:

- Avoid exposing furniture directly to sunlight or heating and air conditioning outlets. Sunlight and or exposure to heating and air conditioning outlets will fade/damage Velvet.
- Vacuum or wipe with a soft cloth to remove dust.



For items use on wooden floor, hard surfaces or carpets, it is recommended to install protective pads under all legs and supports to avoid/prevent from damages/scratches and discoloration.