





# ASSEMBLING INSTRUCTIONS

## ITEM NO: 9204CC-1PW&9204MT-1PW POWER RECLINING CHAIR

NO.	PARTS LIST	QTY	DESCRIPTION
A		1	SEAT
B		1	BACK REST

NO.	HARDWARE LIST	QTY	DESCRIPTION
C		1	LSF EAR
D		1	RSF EAR
E		1	PLUG WITH WIRE

**Step 1 #** Align the femal metal bracket at the back onto the male metal bracket at the seat, insert back rest to the seat then push to the end and make sure it is fixed in position securely.

**Step 2 #** Align the metal bracket at the ear onto the male metal bracket at the back rest, push the ear down and make sune it is fixed in position securely.

**Step 1**

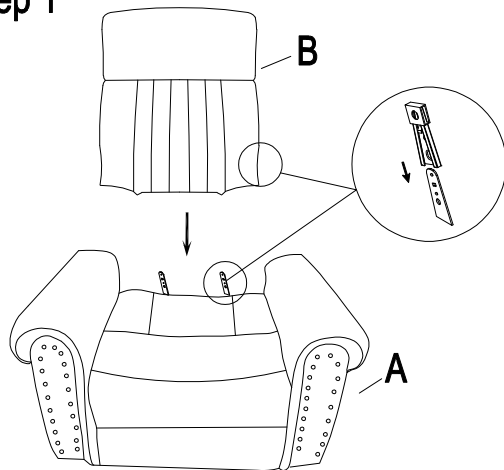

**Step 2**

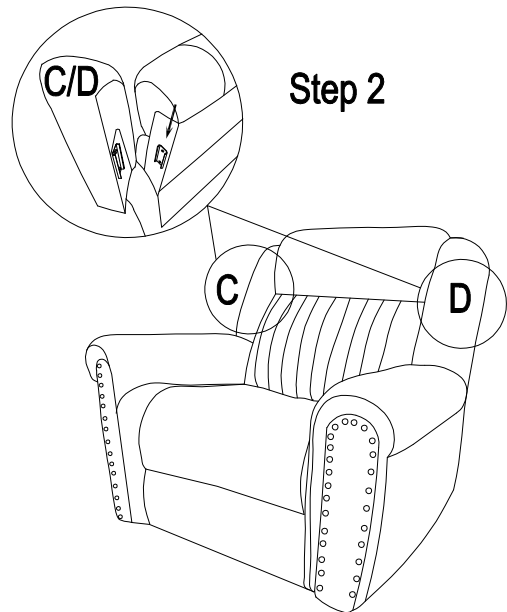

**Step 3**

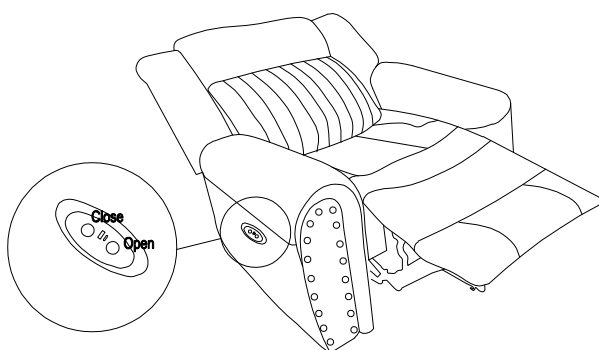

**Step 4 # Completed**

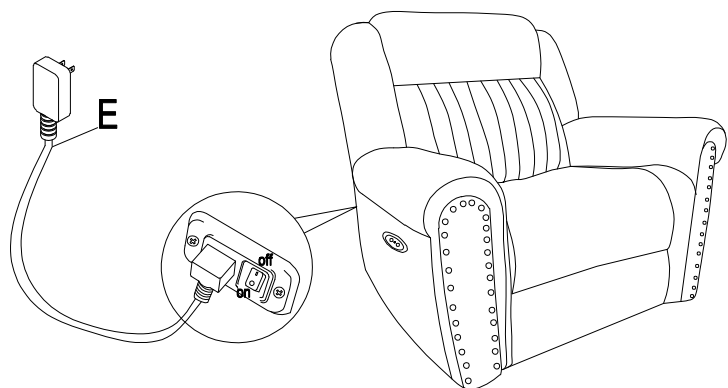

### CARE INTRUCTION POLYESTER FURNITURE

In order to maintain the original appearance of your polyester, please follow below simple care procedures.

\*Avoid exposing furniture directly to sunlight or heating and air conditioning outlets. Exposure to sunlight or heating and air conditioning outlets will fade/damage polyester.

\*Wipe gently with a damp soft cloth to remove dust, dirt and any grime build up.

## Step 5

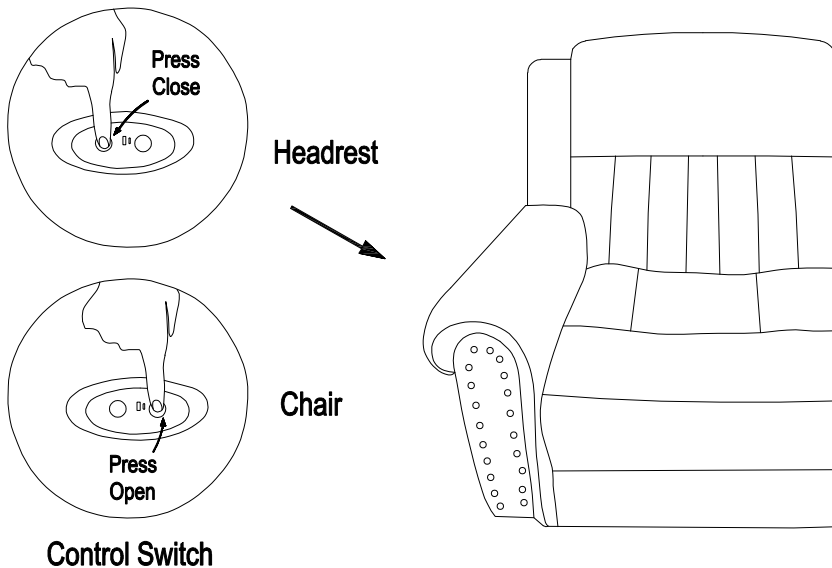

### ● CARE INSTRUCTION FOR POLYESTER:

In order to maintain the original appearance of your polyester furniture, please follow below simple care procedure.

- Avoid exposing furniture directly to sunlight or heating and air conditioning outlets. exposure to sunlight or heating and air conditioning outlets will fade/damage polyester.
- Wipe gently with a damp soft cloth to remove dust, dirt and any grime build up.



## WARNING

- Disconnect the electrical plug from the wall outlet before cleaning, moving, serving or when not in use for an extended period of time.
- Plug directly into a wall outlet. Do not use an extension cord or adaptor.
- Check the condition of the power transformers, electrical cords, plugs and connectors monthly. Keeps the power adaptor and electrical cords away from heat sources. Never operate the unit with a damaged power adaptor, electrical cord, plug or connector.
- Before moving the product, please disconnect the electrical plug from the wall outlet and secure the mechanism to prevent unexpected opening or movement. Never move the product by the mechanism, legrest, or reclining back.
- Do not attempt to disassemble or service the adaptor or motor. No serviceable part are inside.
- Do not allow electrical cord to be pinched between moving parts or between the frame and the floor . Do not place cord under carpet or in location where it could become worn.
- Unplug the power cord immediately if you detect strange odors or fumes coming from the chair.

## FCC Instructions

**Caution:** Changes or modifications not approved by the party responsible for compliance could void user's authority to operate the equipment.

**NOTE:** This equipment has been tested and found to comply with the limits for a class B digital device, pursuant to part 15 of the FCC Rules. These limits are designed to provide reasonable protection against harmful interference in a residential installation. This equipment generates, uses and can radiate radio frequency energy and, if not installed and used in accordance with the instructions, may cause harmful interference to radio communications. However, there is no guarantee that interference will not occur in a particular installation. If this equipment does cause harmful interference to radio or television reception, which can be determined by turning the equipment off and on, the user is encouraged to try to correct the interference by one or more of the following measures:

- Reorient or relocate the receiving antenna.
- Increase the separation between the equipment and receiver.
- Connect the equipment into an outlet on a circuit different from that to which the receiver is connected.
- Consult the dealer or an experienced radio/TV technician for help.