

ASSEMBLY INSTRUCTION / INSTRUCTION D'ASSEMBLAGE

5442 Arm Chair / Chaise A' Bras

Thank you for purchasing this product. Please take time to read and follow the instructions below. Check that you have all parts and hardware before assembly. Parts apparently missing are often found in the packing materials. If you do not have all the parts listed, have your dealer contact us and they will be sent to you immediately.











It is recommended to install protective pads under all legs and support to avoid damage or scratches when placing furniture on a wood floor or other hard surface, and to limit indentation and prevent discoloration if placing on carpet.

Merci d'avoir acheté ce produit. Veuillez lire et suivre les instructions ci-dessous. Vérifiez avant le montage que vous avez toutes les pièces et fixations. Les pièces qui semblent manquer se trouvent souvent dans les matériaux d'emballage. Si vous n'avez pas toutes les pièces de la liste, demandez à votre détaillant et nous les enverrons immédiatement.



Il est recommandé de placer des coussins protecteurs sous tous les pieds et toutes les bases des meubles pour éviter d'endommager ou d'égratigner les planchers en bois ou autres surface dures, et pour limiter l'empreinte et empêcher la décoloration quand les meubles reposent sur la moquette.

PARTS LIST / LISTE DE PIÈCES				HARDWARE LIST / LISTE DE QUINCAILLERIE			
A		Chair back With seat / Dossier de chaise	1	1		Bolt / Boulon 1/4" - 20 x 2"	8
				2		Lock washer / Rondelle d'arrêt 1/4" x 17/64" x 25/64" x 1/16"	8
B		Front Legs / Pied Avant	2	3		Flat Washer / Rondelle Plate 1/4" x 17/64" x 3/4" x 5/64"	8
C		RSF Rear Legs / Pied Arrière	1	4		Allen Key / Clé Allen 1/6"	1
D		LSF Rear Legs / Pied Arrière	1	* HARDWARE SET ARE PACKED IN #5442 FOR ASSEMBLY			

STEP 1 / ÉTAPE 1

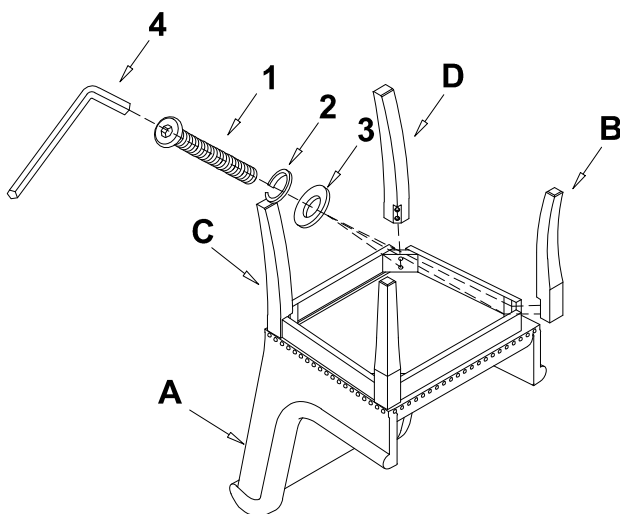

STEP 2 / ÉTAPE 2

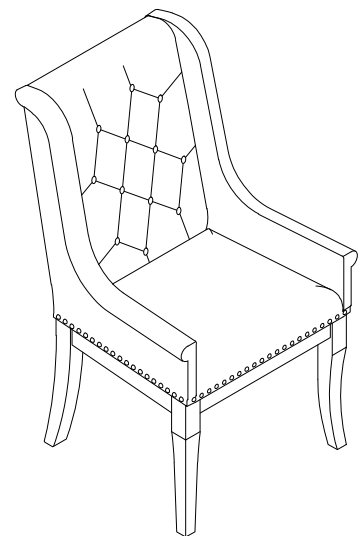

DO NOT TIGHTEN BOLTS UNTIL COMPLETELY ASSEMBLED.

NE PAS SERRER LES BOULONS JUSQU'À CE QUE LE MONTAGE SOIT COMPLETMENT