





ASSEMBLY INSTRUCTION INSTRUCTION D'ASSEMBLAGE

ITEM NO: 3695-04
END TABLE/TABLE DE BOUT



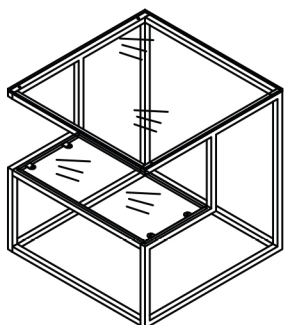

Thank you for purchasing this product. Please take time to read and follow instructions below. Check that you have all parts and hardware before assembly. Parts apparently missing are often found in packing materials. If you do not have all parts listed, call us and they be sent to you immediately



Merci d'avoir acheté ce produit. Veuillez lire et suivre les instructions ci-dessous. Vérifiez avant le montage que vous avez toutes les pièces et fixations. Les pièces qui semblent manquer se trouvent souvent dans les matériaux d'emballage. Si vous n'avez pas toutes les pièces de la liste, demandez à votre détaillant et nous vous les enverrons immédiatement.



 It is recommended to install protective pads under all legs and supports to avoid damage or scratches when placing furniture on a wood floor or other hard surface, and to limit indentation and prevent discoloration if placing on carpet.

 Il est recommandé de placer des coussins protecteurs sous tous les pieds et toutes les bases des meubles pour éviter d'endommager ou d'égratigner les planchers en bois ou autres surfaces dures, et pour limiter l'empreinte et empêcher la décoloration quand les meubles reposent sur la moquette.

PARTS LIST / LISTE DE PIÈCES				
NO.	SKETCH/ ESQUISSE	DESCRIPTION/ LA DESCRIPTION	CARTON	Q'TY/ Q'TÉ
A		GLASS TOP		1PC
B		GLASS SHELF		1PC
C		FRAME C		1PC
D		FRAME D		1PC
E		CONNECTING BAR		6PC

HARDWARE LIST / LISTE DE QUINCAILLERIE				
NO.	DESCRIPTION/ LA DESCRIPTION	SIZE/ TAILLE	SKETCH/ ESQUISSE	Q'TY/ Q'TÉ
1	BOLT	M6*13		24PCS
2	ALLEN KEY	4MM		1PC
3	GLASS HOLDER			8PCS

** ABOVE HARDWARE ARE PACKED IN #3695-04 FOR ASSEMBLY.
LE MATÉRIEL CI-DESSUS EST EMBALLÉ DANS # 3695-04 POUR L'ASSEMBLAGE

Step 1/

Étape 1

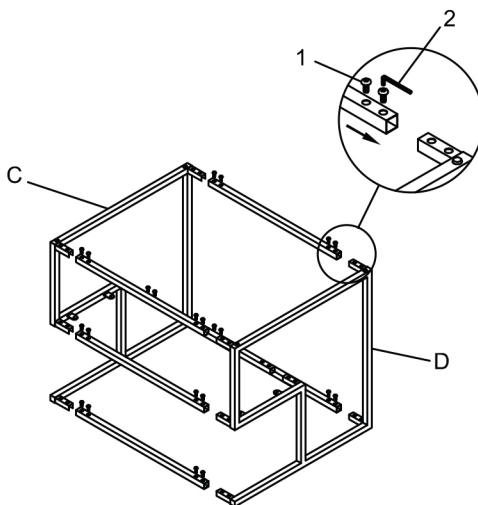

DO NOT TIGHTEN BOLTS UNTIL COMPLETELY ASSEMBLED.
NE PAS SERRER LES BOULONS JUSQU'À CE QUE LE MONTAGE SOIT
COMPLÈTMENT TERMINÉ
HARDWARE MAY LOOSEN OVER TIME. PERIODICALLY CHECK TO
MAKE SURE ALL CONNECTIONS ARE TIGHT.
RE-TIGHTEN IF NECESSARY.
MADE IN CHINA / FABRIQUÉ EN CHINE

Step 2/

Étape 2

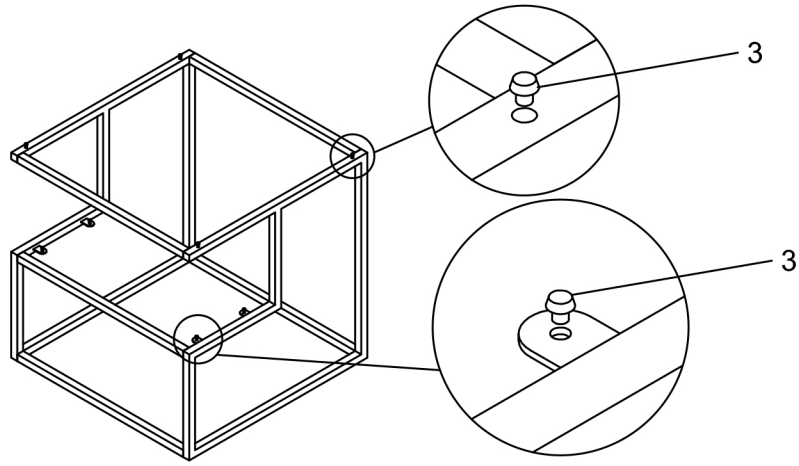

Step 3/

Étape 3

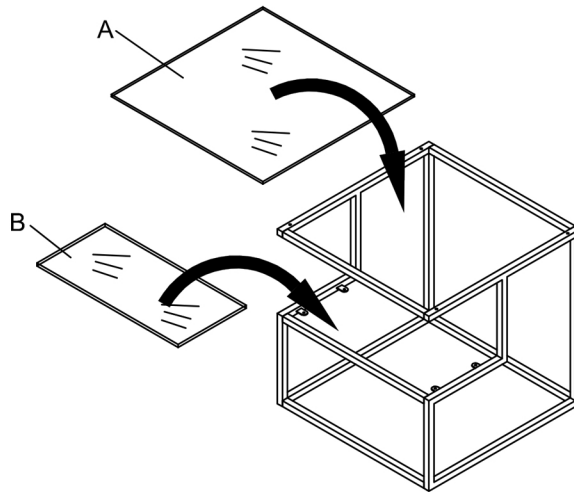

Step 4/

Étape 4

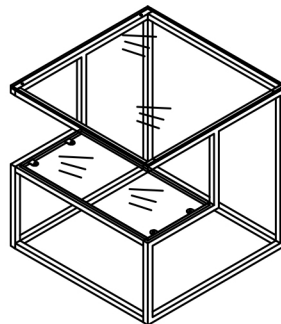

ASSEMBLY COMPLETED /
ASSEMBLAGE COMPLÉTÉ

DO NOT TIGHTEN BOLTS UNTIL COMPLETELY ASSEMBLED.
NE PAS SERRER LES BOULONS JUSQU'À CE QUE LE MONTAGE SOIT
COMPLÈTMENT TERMINÉ
HARDWARE MAY LOOSEN OVER TIME. PERIODICALLY CHECK TO
MAKE SURE ALL CONNECTIONS ARE TIGHT.
RE-TIGHTEN IF NECESSARY.
MADE IN CHINA / FABRIQUÉ EN CHINE