





Assembly Instruction

ITEM NO. 8260GY/DB-ARPW

POWER ARMLESS RECLINING CHAIR

NOTE: Do not use power tools for assembly. Power tools increase the risk of over tightening which lead to splitting or cracking the wood.

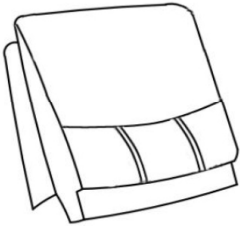
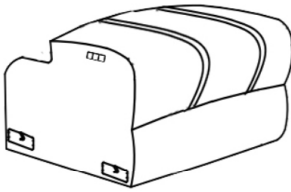
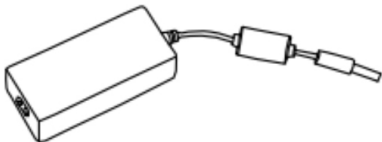
PARTS LIST

NO.	DRAWING	QTY	DESCRIPTION
A		1	BACK REST
B		1	SEAT
C		1	ADAPTOR
D		1	PLUG WIRE

Please follow the drawings below to assemble the item.

Step 1. Align the female brackets at the back onto the male brackets at the seat, insert and push to the end, make sure the brackets are secured in position.

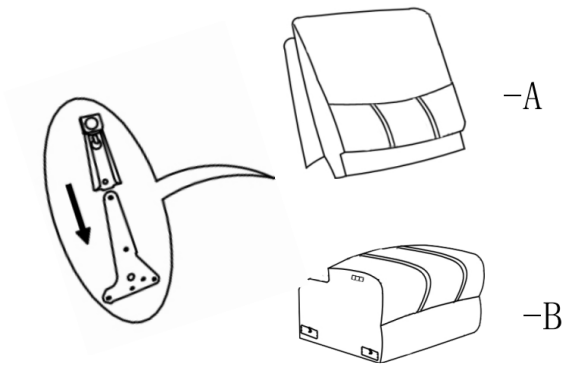

Step 2. Completed.

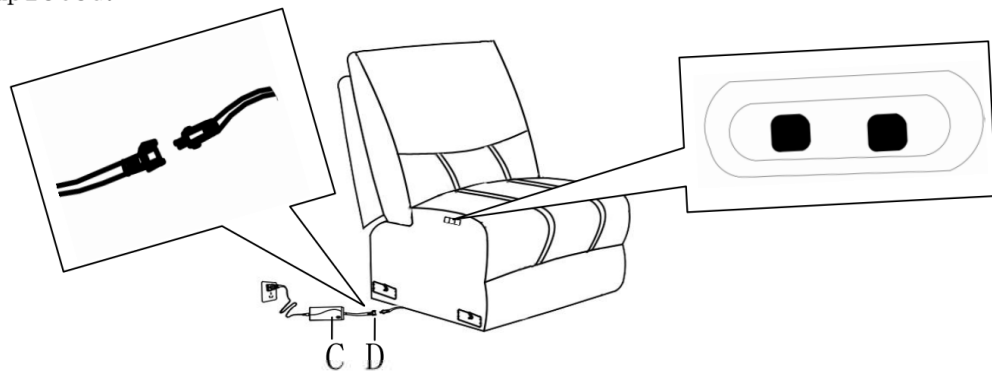

Step 3. Please connect and hook each piece together as shown in drawing.

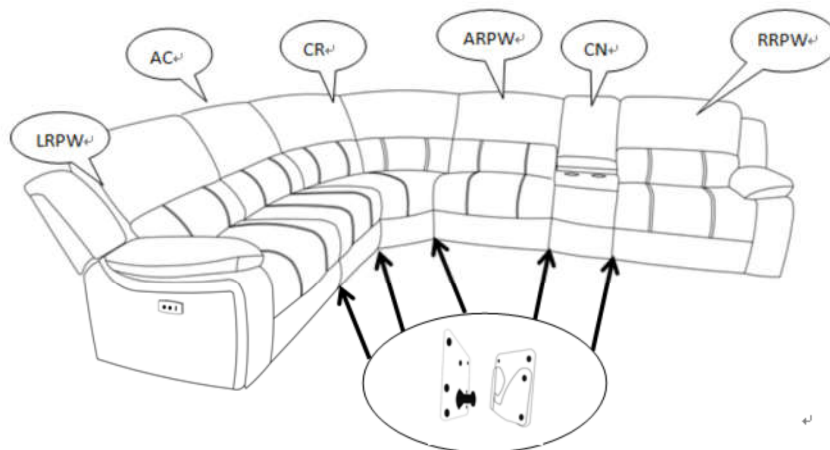

CARE INSTRUCTION FOR LEATHER GEL MATCH FURNITURE:

- Avoid exposing furniture directly to sunlight or heating and air conditioning outlets. Exposure to sunlight or heating and air conditioning outlets will fade/damage leather gel match.

- Wipe gently with a damp soft cloth to remove dust, dirt and any grime buildup.

- Wipe the leather gel match with professional cleanser.



For items use on wooden floor, hard surfaces or carpets, it is recommended to Install protective pads under all legs and supports to avoid/prevent from damages/scratches and discoloration.