

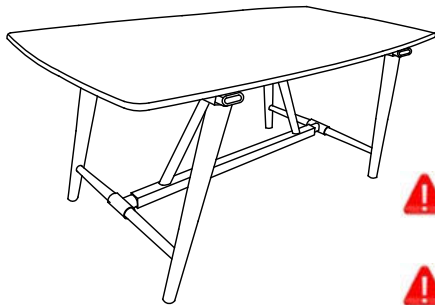

ASSEMBLY INSTRUCTION INSTRUCTION D' ASSEMBLAGE ITEM NO: 5901-71 DINING TABLE

Thank you for purchasing the product. Please take time to read and follow the instructions below. Check that you have all parts and hardware before assembly. Parts apparently missing are often found in the packing materials. If you do not have all the parts listed, have your dealer contact us and they will be sent to you immediately.

Merci d'avoir acheté ce produit. Veuillez lire et suivre les instructions ci-dessous. Vérifiez avant le montage que vous avez toutes les pièces et fixations. Les pièces qui semblent manquer se trouvent souvent dans les matériaux d'emballage. Si vous n'avez pas toutes les pièces de la liste, demandez à votre détaillant et nous les enverrons immédiatement.



It is recommended to install protective pads under all legs and supports to avoid damage or scratches when placing furniture on a wood floor or other hard surface, and to limit indentation and prevent discoloration if placing on carpet.







Il est recommandé de placer des coussins protecteurs sous tous les pieds et toutes les bases des meubles pour éviter d'endommager ou d'égratigner les planchers en bois ou autres surfaces dures, et pour limiter l'empreinte et empêcher la décoloration quand les meubles reposent sur la moquette.





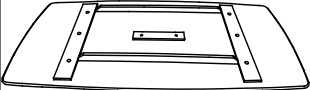
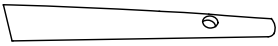
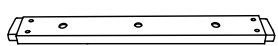

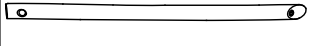

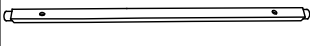

Hardware may loosen over time. Periodically check to make sure all connections are tight. Re-tighten if necessary.



Le matériel peut se desserrer au fil du temps. Vérifiez périodiquement que toutes les connexions sont serrées. Serrer à nouveau si nécessaire.

PARTS LIST / LISTE PIÈCES			
No	Sketch	Description	Quantity
1		Table Top Dessus De Table	1PC
2		Leg Pied	4PCS
3		Mounting Plate Plaque De Montage	2PCS
4		Side Cross Bar Barre Transversale	2PCS
5		Center Support Barre De Soutien	2PCS
6		T Connector Connecteur En T	2PCS
7		Stretcher Tendeur	1PC

HARDWARE LIST/LISTE DE QUINCAILLERIE				
No	Description	Size	Sketch	Quantity
A	JCBC Bolt/Boulon	M6X50mm		10PCS
B	JCBB Bolt/Boulon	M8X50mm		8PCS
C	Spring Washer Rondelle d'arrêt	M8X13mm		18PCS
D	Flat Washer Rondelle Plate	M8X18mm		18PCS
E	Wood Screw/Vis	M4X25mm		6PCS
F	Wood Screw/Vis	M5X38mm		4PCS
G	Allen Key/Cle Allen	M4		1PC
H	Allen Key/Cle Allen	M5		1PC

**Above hardware are packed in 5901-71 for assembly.

STEP 1 / ÉTAPE 1

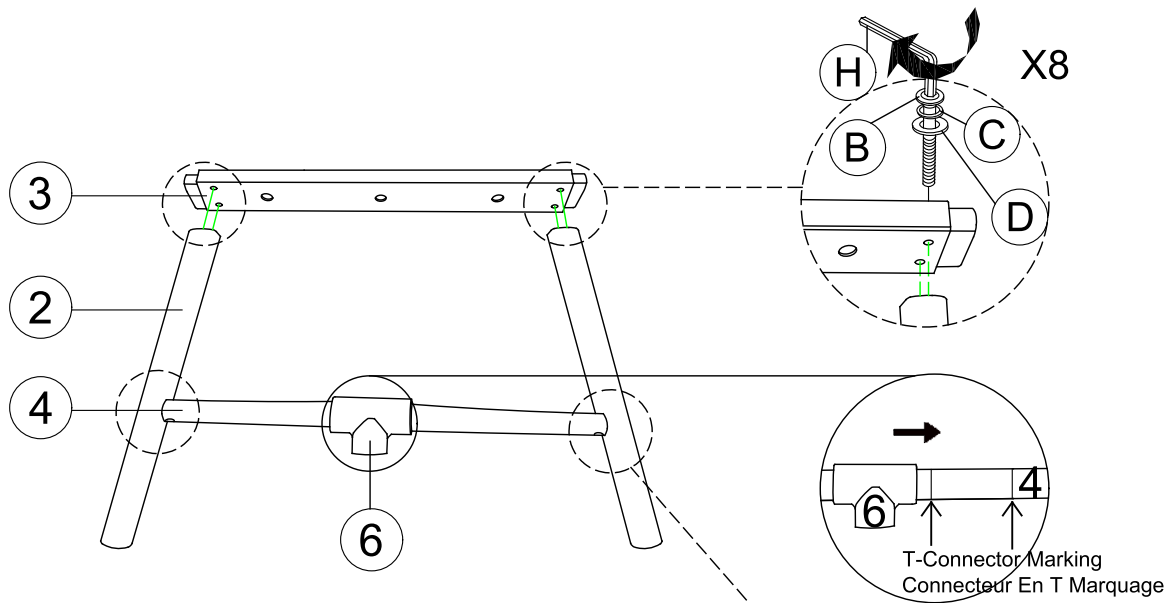

STEP 2 / ÉTAPE 2

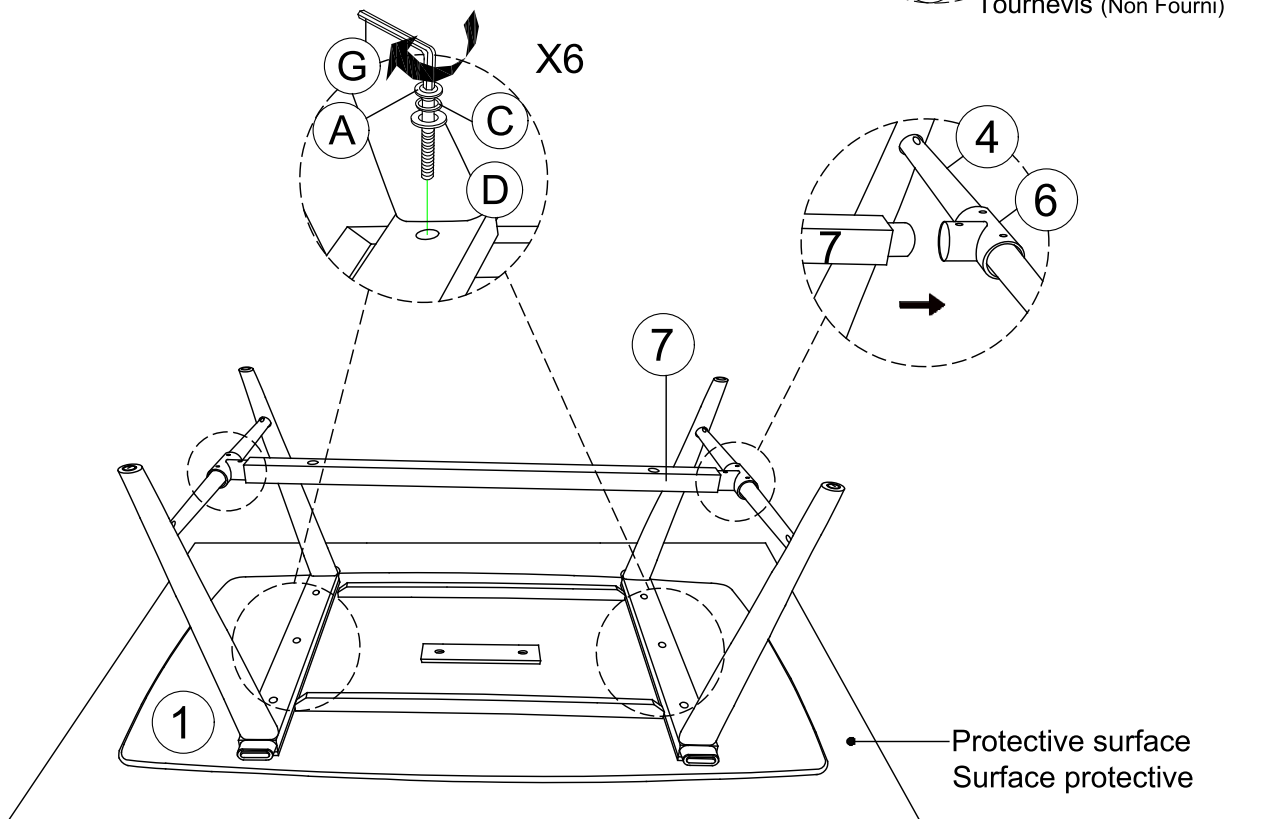

STEP 3 / ÉTAPE 3

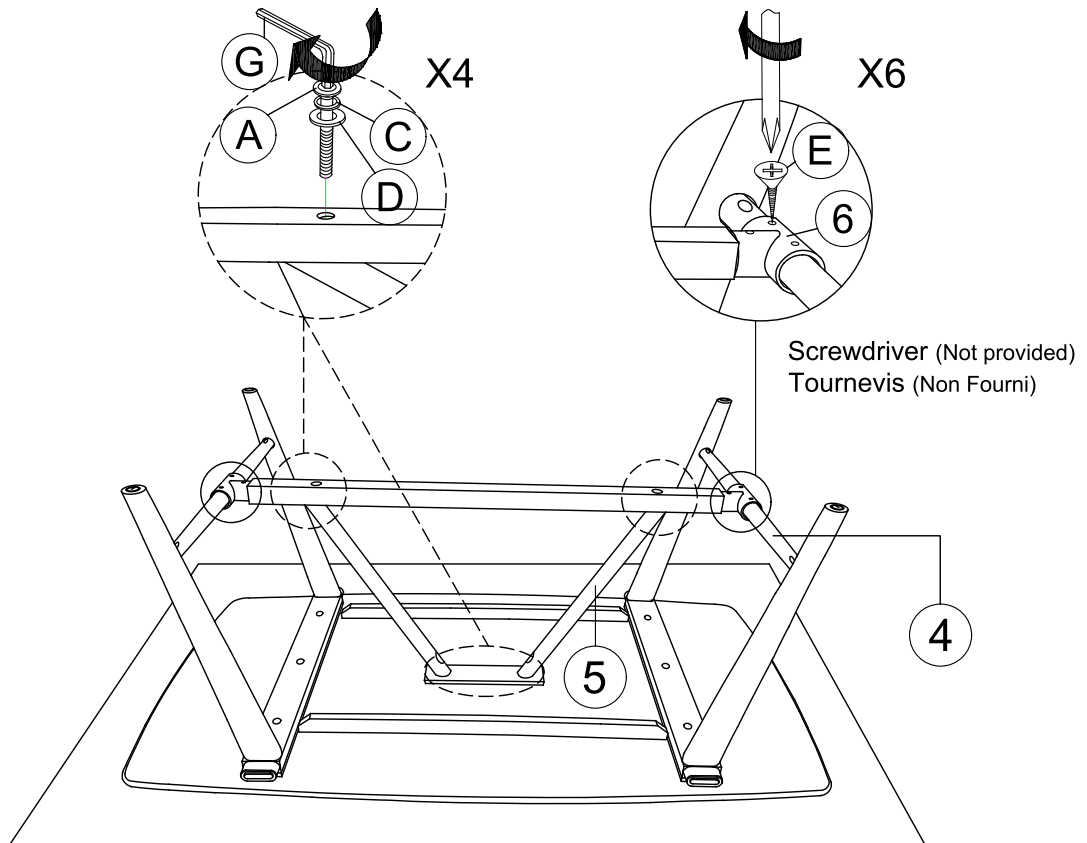

STEP 4 / ÉTAPE 4 COMPLETED / COMPLÉTÉ

