

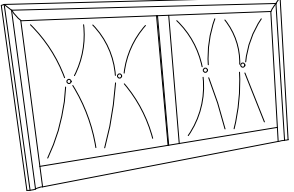

ASSEMBLY INSTRUCTION / INSTRUCTION D'ASSEMBLAGE



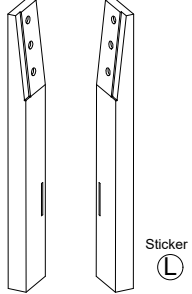

ITEM NUMBER : 2145K-1 EK/CK King Headboard /
Tête de lit – Tres Grand Lit

NO	Parts List / Liste de Pieces	QTY
----	------------------------------	-----

1	Headboard / Tête de Lit 	1pc
---	--	-----

NO	Hardware List / Liste de Quincaillerie	QTY
2	Leg / Pied Gauche / Droit 	2pcs

A	JCBC SCREW / BOULON M6 x 35mm	6pcs
B	SPRING WASHER / RONDELLE D'ARRÊT Ø1/4"	6pcs
C	FLAT WASHER RONDELLE PLATE Ø1/4" x 13mm	6pcs
D	L - KEY CLÉ ALLEN M4 x 65mm	1pc

-  It is recommended to install protective pads under all legs and supports to avoid damage or scratches when placing furniture on a wood floor or other hard surface, and to limit indentation and prevent discoloration if placing on carpet.
-  Il est recommandé de placer des coussins protecteurs sous tous les pieds et toutes les bases des meubles pour éviter d'endommager ou d'égratigner les planchers en bois ou autres surfaces dures, et pour limiter l'empreinte et empêcher la décoloration quand les meubles reposent sur la moquette.
-  Hardware may loosen over time. Periodically check to make sure all connections are tight. Re-tighten if necessary.
-  Le matériel peut se desserrer au fil du temps. Vérifiez périodiquement que toutes les connexions sont serrées. Serrer à nouveau si nécessaire.

STEP / ÉTAPE 1

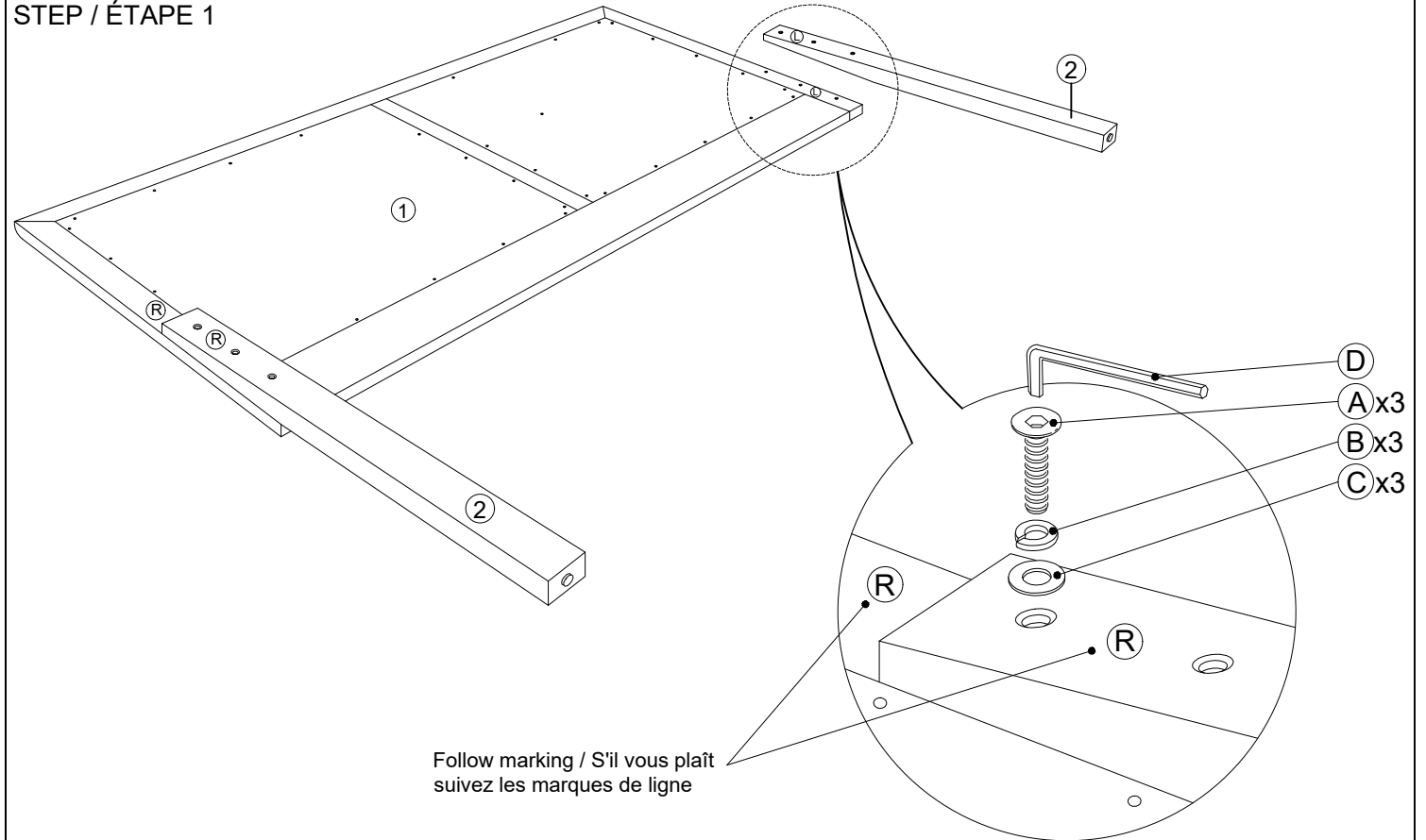

DO NOT TIGHTEN BOLTS UNTIL COMPLETELY ASSEMBLED. / NE PAS SERRER LES BOULONS JUSQU'À CE QUE LE MONTAGE SOIT COMPLETMENT TERMINE.