

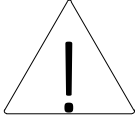

H O M E E L E G A N C E

Assembly Instruction Swivel Chair





ITEM NO.:1003RNG/TPE/DGY/GRN/GRY-1

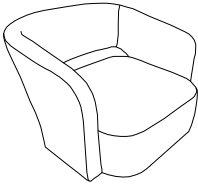

Swivel base is located on the chair seat, hardware set is located inside the carton for assembly.

Note: Do not use power tools for assembly. Power tools increase the risk of over tightening which lead to splitting or cracking the wood.

Component list

No	Drawing	Qty	Description
A		1	Swivel Chair Seat
B		1	Swivel Base
C		4	Bolts 1/4"*25mm
D		4	Flat Washers Ø19*Ø6*1.5mm
E		4	Lock Washers 1/4"*1.3mm
F		1	Allen Wrench M5*70*70mm

Step #1

Hardware package on the inner wall of the carton.

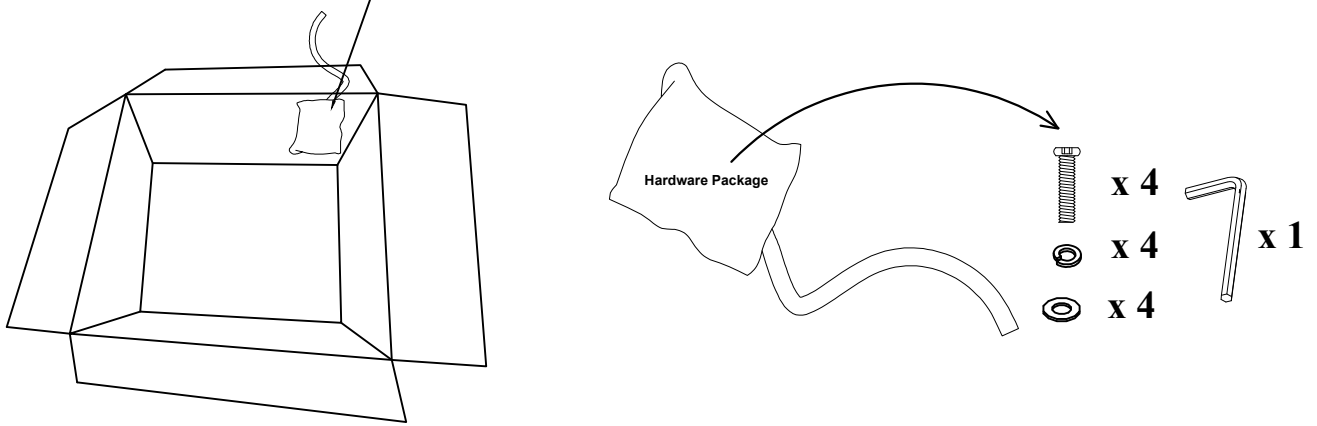

Step #2

Swivel base on swivel chair seat.

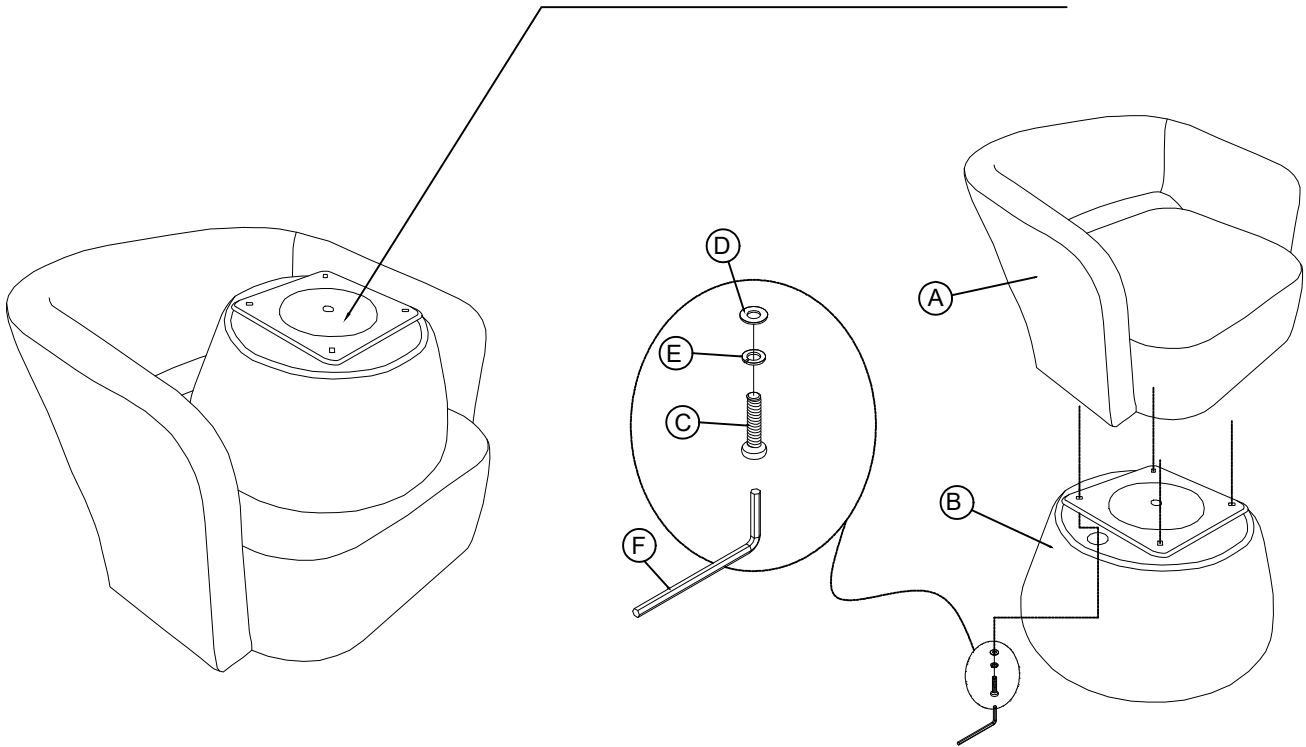

Step #3

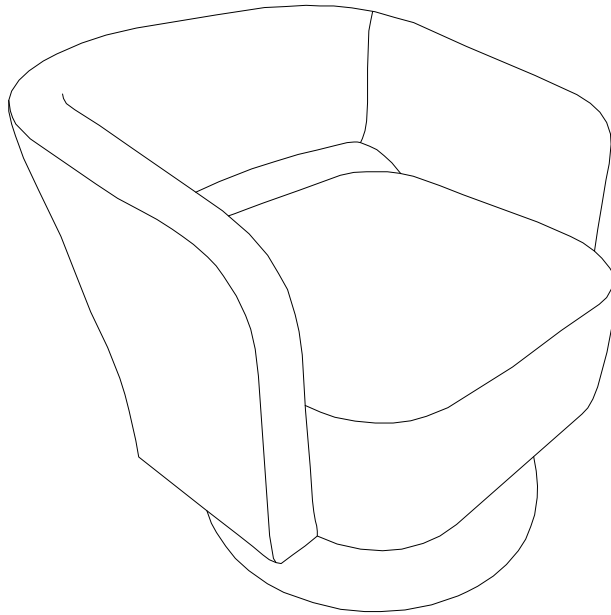

Care Instruction for Velvet Furniture:

In order to maintain the original appearance of your velvet Furniture, please follow below simple care procedures:

- Avoid exposing furniture directly to sunlight or heating and air conditioning outlets. Sunlight and or exposure to heating and air conditioning outlets will fade/damage velvet.
- Vacuum or wipe with a soft cloth to remove dust.
- Hardware may loosen over time. Periodically check to make sure all connection are tight, Re-tighten if necessary



For items use on wooden floor, hard surfaces or carpets, it is recommended to Install protective pads under all legs and supports to avoid/prevent from damages/scratches and discoloration.